



DX700LC

Engine Power : SAE J1349,net 345kw(463 HP)@1,800 rpm

Operational Weight : 70,100kg - STD.

Bucket capacity(SAE): 2.5 ~5.2 m³





DX700LC

A New Model DX 700 LC Hydraulic Excavator :

Increased production and improved fuel economy is attributed to the electronic optimization of the hydraulic system and the new generation DOOSAN DX700LC engine (ISUZU Tier-3 Stage). Improved ergonomics increases comfort and excellent all round visibility ensuring a safe and pleasant working environment. Improved reliability is achieved through the use of high performance materials combined with new methods of structural stress analysis, and leads to increased component life expectancy, thus reducing running costs. Reduced maintenance increases the availability and reduces operating costs of the excavator.



Performance



The performance of the DX 700LC has a direct effect on its productivity. Its new "Common Rail" engine and new e-EPOS controlled hydraulic system have combined to create an unbeatable hydraulic excavator, with a cost/performance ratio that makes the DX 700 LC even more appealing.

DOOSAN DX 700LC ENGINE

Maker & Model	ISUZU MOTORS AH-6WG1XYSC-01
Cooling Fan	Not Installed
Alternator	24V, 80A
Air Cleaner	Installed
Muffler	Installed
Rated Horse Power	345 kW(469 PS) @ (DIN 6271)
	345 kW(463 HP) @ (SAE J1349)
Max. Torque	202 kgf.m @ 1,500 rpm
Fuel Consumption (Max, Rated)	214 g/kw.hr @ RATED SPEED

The new DOOSAN DX700LC ISUZU engine respects and protects the environment, limiting all types of toxic emissions.

Cooling System

- The Doosan Cooling Fan Control (DCFC) controls the fan speed, based on coolant temperature and hydraulic oil temperature
ED REGURATOR VALVE Controls hyd. oil flow inside fan pump
- Audible and visible monitoring sensor
Water temperature sensor activates water temperature gauge at cluster, overheat prevention system and automatic warming up system.
- Overheat prevention system
When coolant temperature reaches 110°C (230°F) buzzer and warning lamp at cluster are activated.

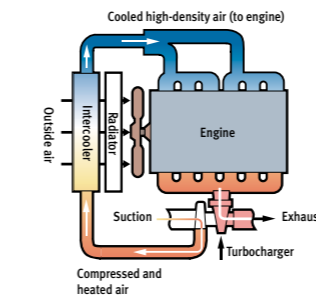
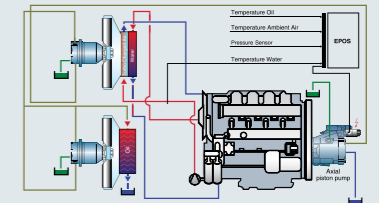

Valve OHC Turbo Engine with Inter-Cooler

Density of the air increases NOx and PM can be reduced substantially Permitting high output Improvement of fuel efficiency

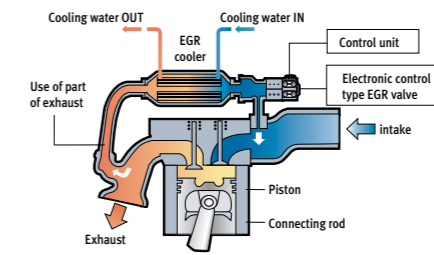

Cooled EGR System

- EGR (Exhaust Gas Recirculation)
- Lower the combustion temp. reducing NOx(Nitrogen Oxide)

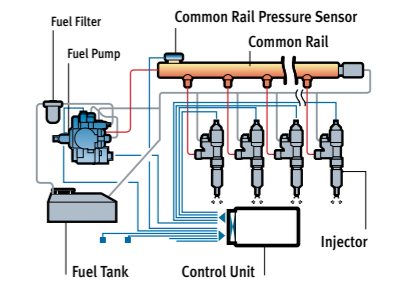

Common Rail Type High-Pressure Fuel Injection System

High Pressure of more 1600atm 1/1000 second optimizes combustion Improves combustion efficiency & reduce PM (Particulate Matter)



Swing Motor

Shocks during rotation are minimized, while increased torque is available to ensure rapid cycles.

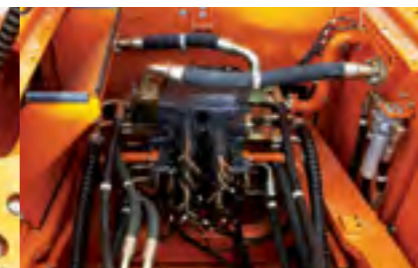

Control Valve

The main control valve of DX700LC has high reliability. Main relief pressure is 320/350 bar.



Hydraulic Pump

The main pump has a capacity of 2x436 /min reducing cycle time while a high capacity gear pump improves pilot line efficiency.

Comfort

The work rate of the hydraulic excavator is directly linked to the performance of its operator. DOOSAN designed the DX 700 LC by putting the operator at the center of the development goals. The result is significant ergonomic value that improves the efficiency and safety of the operator.



Control panel

More space, better visibility, air conditioning, a very comfortable seat... These are all elements that ensure the operator can work for hours and hours in excellent conditions.

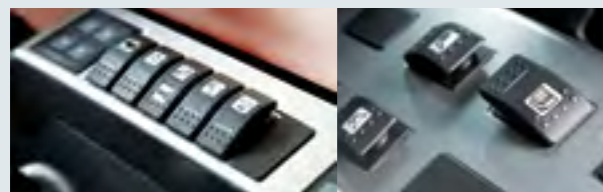

Control stand (Telescopic Function)

Comfortable 2-stage sliding seat



Control lever

Very precise control of the equipment increases versatility, safety and facilitates tricky operations requiring great precision. Leveling operations and the movement of suspended loads are made easier and safer.



1. Control panel

2. Operation modes

Choice of operating modes

- Power Mode** - Heavy duty digging & loading
- Uses 100% Engine power for all work
- STD Mode** - Heavy duty dumping, General, Breaker
- Flow Distribution Control (Boom, Swing Priority, etc.)
- Uses 85% Engine power for all work
- E Mode** - Middle duty dumping, digging & loading
- Uses 75% Engine power for all work
- Lifting Mode** - Pipe or Beam lifting
- Uses 80% Engine power for all work

Rear Camera



1. Cellular phone box
2. 24V Power socket
3. Cigarette lighter
4. Glass antenna

Reliability & Maintenance



The reliability of a product contributes to its overall lifetime operating costs.

Doosan uses computer-assisted design techniques, highly durable materials and a quality engineered structure. Our research and development engineers test all product under the most extreme conditions. Durability, reliability and product longevity are Doosan's top priorities.

● **Strengthened Boom**

The shape of the boom has been optimized by finite elements design, allowing uniform load distribution throughout the structure.

● **Arm Assembly**

In the arm assembly greater strength has been gained by using cast elements and reinforcement around the bosses to give increased life.



Bushing

A highly lubricated metal is used for the boom pivot in order to increase the lifetime and extend the greasing intervals to 250 hours.



Ultra-hard wear-resistant disc

New materials have been used in order to increase the wear resistance and to increase the service intervals.



X-chassis

The X-chassis frame section has been designed using finite element and 3-dimensional computer simulation

Adjustable Track Frame



Shoe

Sprocket

Wide Side Step



Easy maintenance

Easy access to the various radiators and coolers makes cleaning easier. Access to the various parts of the engine is from the top and via side panels.



Dual Engine Oil Filter

The engine oil filter offers a high level of filtration allowing the oil change interval to be increased to 500 hours.



Hydraulic oil return filter

The protection of the hydraulic system is more effective, using glass fiber filter technology in the main oil return filter.



Dual Stage Air Cleaner with Pre-cleaner

The large capacity forced air cleaner removes over 99% of airborne particles, reducing the risk of engine contamination and making the cleaning and cartridge change intervals greater.



Double Fuel Pre - Filter

High efficiency fuel filtration is attained by the use of multiple filters, including a fuel pre-filter fitted with a water separator that removes most moisture from the fuel.

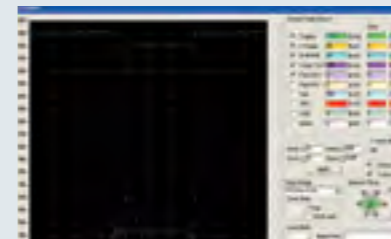

PC Monitoring (DMS)

A PC monitoring function enables connection to the e-EPOS system, allowing various parameters to be checked during maintenance



Convenient Fuse Box

The fuse box is conveniently located in a section of the storage compartment behind the operator's seat providing a clean environment and easy access.



Auto Greasing System in the all Lubrication Point (Optional)

Bucket, Arm, Boom, Swing Bearing & Device are all auto greasing system(STD).

DX700LC



Hydraulic Excavator
DX700LC



Technical Specification

Engine

MODEL ISUZU MOTORS AH-6WG1XYSC-01
TYPE Water-Cooled, Common Rail, Direct Injection
NUMBER OF CYLINDERS 6
RATED HORSE POWER 345 kW (469 PS) @ 1,800 rpm (DIN 6271) 345 kW (463 HP) @ 1,800 rpm (SAE J1349)
MAX TORQUE 202kgfm@ 1,500rpm
PISTON DISPLACEMENT 15,681cc
BORE & STROKE Ø147mm x 154mm
STARTING MOTOR 24 Vx7.0 kW
BATTERIES 12 V x 2/150 AH
AIR CLEANER Double element with precleaner

Weight

TRIPLE GROUSER		
Shoe width	Operating weight	Ground pressure (kgf/cm ²)
(STD)650DG mm	70,100 kg	1.02 kgf/cm ²
(OPT)750DG mm	71,100 kg	0.91 kgf/cm ²
(OPT)900DG mm	72,100 kg	0.77 kgf/cm ²

Hydraulic System

The heart of the system is the e-EPOS (Electronic Power Optimizing System). It allows the efficiency of the system to be optimized for all working conditions and minimizes fuel consumption. The new e-EPOS is connected to the engine electronic control via a data transfer link to harmonize the operation of the engine and hydraulics.

- The hydraulic system enables independent or combined operations.
- Two travel speeds offer either increased torque or high speed tracking.
- Cross-sensing pump system for fuel savings.
- Auto deceleration system.
- Two operating modes, two power modes.
- Button control of flow in auxiliary equipment circuits.
- Computer-aided pump power control.

MAIN PUMPS Tandem, Axial Piston max flow : 2-436 l/min Displacement - 242 X 2 cc/rev weight - 300kg
--

PILOT PUMP Gear pump - max flow rate - 27 l/min Displacement : 15 cc/rev Relief valve pressure - 39.8 kgf/cm ²

MAIN RELIEF PRESSURE Boom/Arm/Bucket Working, Travel - 320 [+10~0] kg/cm ² Pressure up - 350 [+10~0] kg/cm ²
--

Hydraulic Cylinders

The piston rods and cylinder bodies are made of high-strength steel. A shock absorbing mechanism is fitted in all cylinders to ensure shock-free operation and extend piston life.

Cylinders	Quantity	Bore x Rod diameter x stroke
Boom	2	Ø190 X Ø125 X 1,795mm
Arm	1(1)	Ø215 X Ø150 X 2030(1890)mm
Bucket	1(1)	Ø190(Ø200) X Ø130 X 1465mm

() : Opt.

Undercarriage

Chassis are of very robust construction, all welded structures are designed to limit stresses. High-quality material used for durability. Lateral chassis welded and rigidly attached to the undercarriage. Track rollers lubricated for life, idlers and sprockets fitted with floating seals. Tracks shoes made of induction-hardened alloy with triple grousers. Heat-treated connecting pins. Hydraulic track adjuster with shock-absorbing tension mechanism

UPPER ROLLERS (STANDARD SHOE) - 3
LOWER ROLLERS - 8
TRACK SHOES - 48
OVERALL LENGTH - 13,250mm
TRACK LENGTH - 5,975mm

Bucket Recommendation

TRACK	STD Track
C/W (ton)	11.3
SHOE (mm)	650

Bucket Type	Capacity		Width		Radius	Weight	6.65m Boom		7.7m Boom		Remark
	SAE	CECE	W/O Cutter	With Cutter			2.6m Arm	2.9m Arm	2.9m Arm	3.55m Arm	
GP	2.50 m ³	2.23 m ³	1,565 mm	-	2,132 mm	2,525 kg	A	A	A	A	A
	3.00 m ³	2.70 m ³	1,805 mm	-	2,132 mm	2,825 kg	A	A	A	A	B
	3.30 m ³	2.90 m ³	1,944 mm	-	2,132 mm	2,965 kg	A	A	A	B	C
	3.90 m ³	3.46 m ³	1,999 mm	-	2,187 mm	3,195 kg	A	A	B	C	D
	4.50 m ³	3.97 m ³	2,249 mm	-	2,187 mm	3,515 kg	A	B	C	D	-
	5.20 m ³	-	2,210 mm	-	2,251 mm	4,120 kg	C	C	-	-	-
HD	3.00 m ³	2.80 m ³	1,676 mm	-	2,146 mm	3,315 kg	A	A	A	A	B
	3.30 m ³	3.00 m ³	1,548 mm	-	2,146 mm	3,460 kg	A	A	A	B	C
	3.90 m ³	3.50 m ³	1,928 mm	-	2,146 mm	3,740 kg	A	A	C	C	D
	4.50 m ³	4.10 m ³	2,180 mm	-	1,619 mm	4,100 kg	B	B	D	D	-
	5.20 m ³	-	2,210 mm	-	2,251 mm	4,535 kg	C	C	-	-	-

This bucket recommendation is based on machine stability considering the tipping load with certain density of handling material, and should be strictly followed. It's more recommendable to use a smaller size of bucket than recommendation under the severe working condition and application to avoid the durability risks.

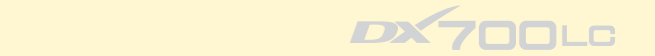

Swing Mechanism

High-torque, axial piston motor with planetary reduction gear bathed in oil. Swing circle is singlerow, shear type ball bearing with induction-hardened internal gear. Internal gear and pinion gear immersed in lubricant.

TYPE - Axial Piston
SWING SPEED - 7.1 rpm (EFF.=0.98)
MAX. SWING TORQUE - 22,070 kgf.m (EFF.=0.77)

Drive

Each track is driven by an independent, high-torque, axial piston motor through planetary reduction gear. Two levers or foot pedal control provide smooth travel or counter-rotation upon demand.

TRAVEL SPEED (HIGH/LOW) - 4.6/2.8km/h (EFF.=97%)
MAXIMUM TRACTION FORCE - 48.9/42.4 ton (EFF.=76.4/65.4%)
GRADEABILITY - 70%

Refill Capacities

FUEL TANK - 900 l (Diesel)
COOLING SYSTEM (RADIATOR CAPACITY) - 69 l (Water)
ENGINE OIL - 52 l
SWING DEVICE - 2x6 l
TRAVEL DEVICE - 2x20 l
LEVER : 350 l
OIL TANK : Lever 350 l SYSTEM (TANK FULL) 790 l

Based on ISO 10567 and SAE J296, arm length without quick change clamp
 A : Suitable for materials with density of 2,100kg/m³ (3,500lb/yd³)
 B : Suitable for materials with density of 1,800kg/m³ (3,000lb/yd³)
 C : Suitable for materials with density of 1,500kg/m³ (2,500lb/yd³)
 D : Suitable for materials with density of 1,200kg/m³ (2,000lb/yd³)
 - : Not recommended

Dimensions

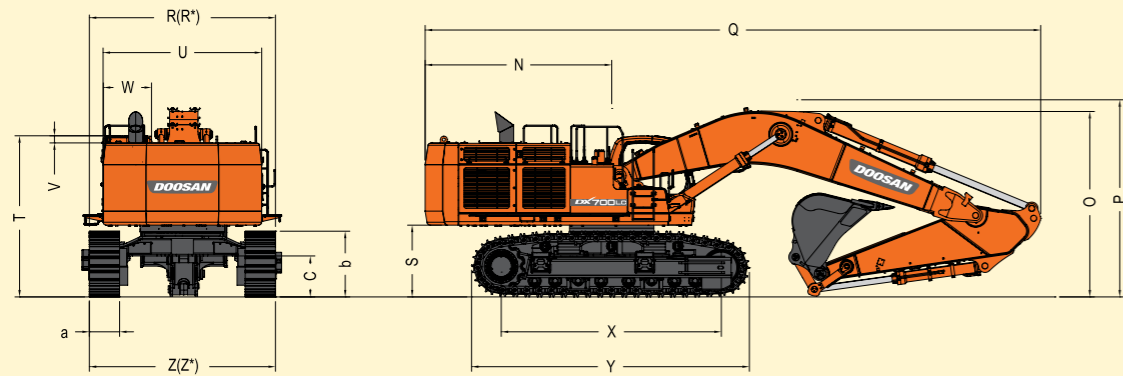

Standard

Boom type (one piece)	(mm)	7,700			6,650		
Arm type	(mm)	3,550	2,900	4,200	2,900	2,600	
Bucket type (SAE)	(m³)	3.3	3.9	3.0	4.5/5.2	4.5/5.2	
Tail swing radius	(mm) N	4,090	←	←	←	←	
Shipping height (boom)	(mm) O	4,063	4,418	5,015	4,920	4,750	
Shipping height (hose)	(mm) P	4,220	4,520	5,130	5,000	4,870	
Shipping length	(mm) Q	13,250	13,400	13,085	12,335	12,335	
Shipping width (std.)	(mm) R	3,560	←	←	←	←	
Shipping width (narrow)	(mm) R*	-	-	-	-	-	
C/Weight clearance	(mm) S	1,525	←	←	←	←	
Height over cab.	(mm) T	3,515	←	←	←	←	
House width	(mm) U	3,410	←	←	←	←	
Cab. Height above House	(mm) V	208	←	←	←	←	
Cab. width	(mm) W	1,010	←	←	←	←	
Tumbler distance	(mm) X	4,730	←	←	←	←	
Track length	(mm) Y	5,975	←	←	←	←	
Undercarriage width (std.)	(mm) Z	3,560/4,000*	←	←	←	←	
Undercarriage width (narrow)	(mm) Z*	-	-	-	-	-	
Shoe width	(mm) a	650	←	←	←	←	
Track height	(mm) b	1,413	←	←	←	←	
Car body clearance	(mm) c	870	←	←	←	←	

[Note] * : Retracted / Extended

Working Range

DX700LC

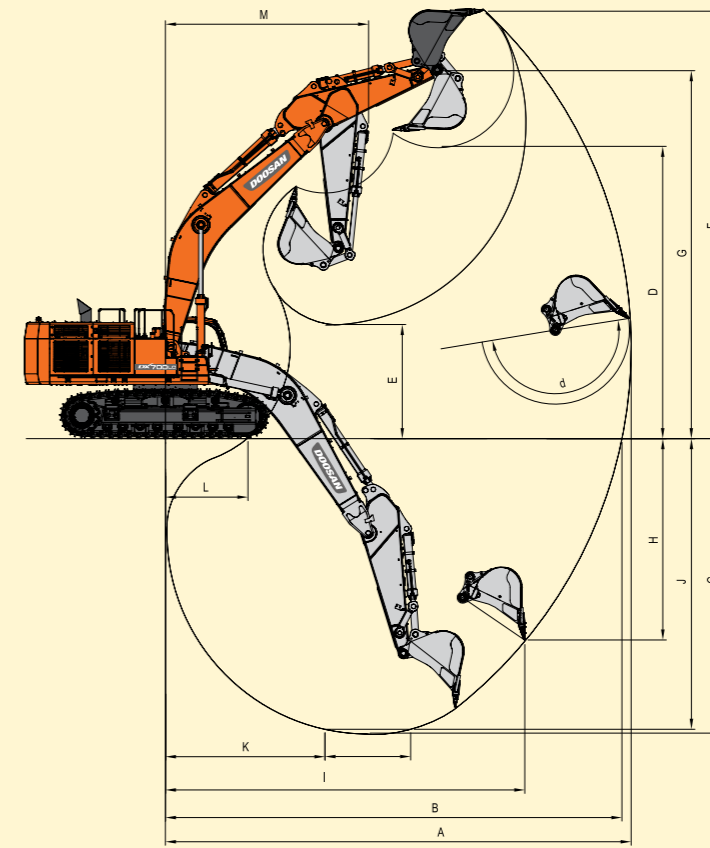

Boom type (one piece)	(mm)	7,700			6,650			
Arm type	(mm)	3,550	2,900	4,200	2,900	2,600	2,900	2,600
Bucket type (SAE)	(m³)	3.3	3.9	3.0	4.5	4.5	5.2	5.2
Max. Digging reach	(mm) A	13,250	12,720	13,865	11,605	11,345	11,641	11,390
Max. Digging reach (ground)	(mm) B	12,990	12,450	13,610	11,305	11,040	11,290	11,085
Max. Digging depth	(mm) C	8,410	7,730	9,030	7,075	6,780	7,140	6,840
Max. loading height	(mm) D	8,320	8,220	8,660	7,020	6,940	6,955	6,880
Min. loading height	(mm) E	3,248	3,950	2,630	3,080	3,380	3,010	3,310
Max. digging height	(mm) F	12,165	12,040	12,520	10,740	10,680	10,560	10,500
Max. bucket pin height	(mm) G	10,470	10,380	10,795	9,210	9,135	9,210	9,135
Max. vertical wall depth	(mm) H	5,730	4,060	6,515	3,450	3,305	1,715	1,580
Max. radius vertical	(mm) I	10,230	10,790	10,360	9,860	9,655	10,805	10,580
Max. depth to 8' line	(mm) J	8,270	7,550	8,910	6,925	6,620	6,990	6,690
Min. radius 8' line	(mm) K	4,540	4,530	10,360	3,800	3,785	3,785	3,790
Min. digging reach	(mm) L	2,350	3,060	170	1,835	2,050	1,835	2,050
Min. swing radius	(mm) M	5,780	5,790	5,810	5,230	5,195	5,230	5,200
Bucket angle	(deg) d	179.4	177.8	179.4	167.4	166.4	154.3	153.4

Lifting Capacity

DX700LC

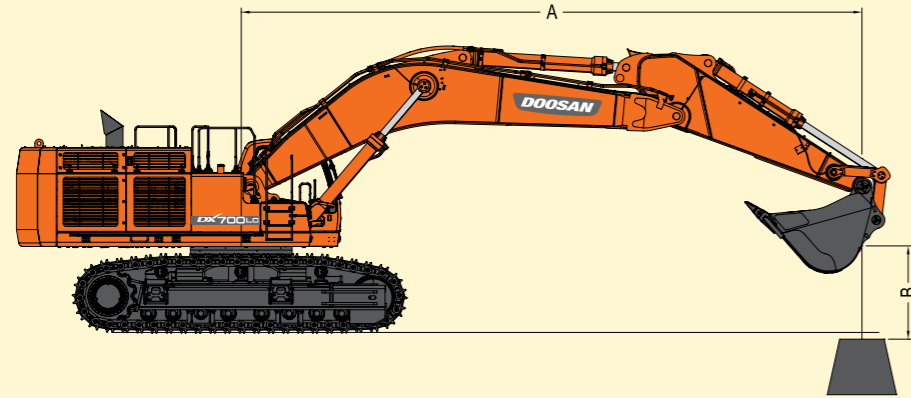

Standard

Boom : 7,700mm(25'3") Arm : 3,550mm(11'3") Bucket : SAE 3.3m³ Shoe : 650mm(2'2") GP Bucket 11,300kg C/W

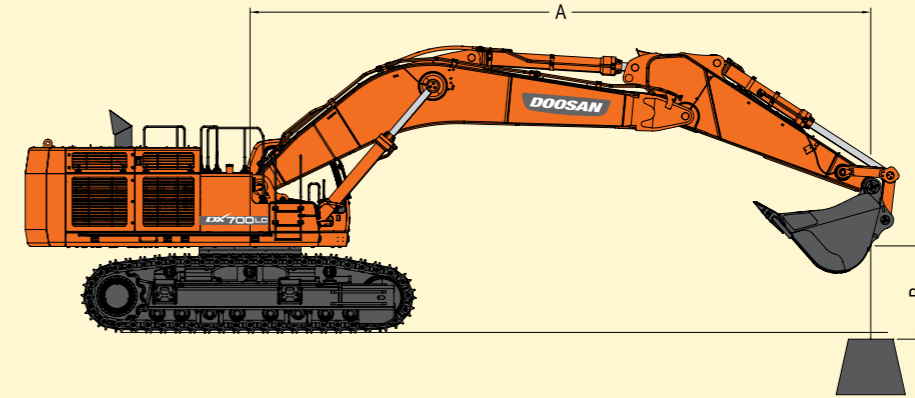

Opton 1

Boom : 7,700mm(25'3") Arm : 2,900mm(9'6") Bucket : SAE 3.3m³ Shoe : 650mm(2'2") GP Bucket 11,300kg C/W

Metric

Unit : 1,000kg



A(m) B(m)	3		4.5		6		7.5		9		10.5		Max. Reach		A(ft)
	Rating Over Front	Rating Over Side or 360 degree	Rating Over Front	Rating Over Side or 360 degree	Rating Over Front	Rating Over Side or 360 degree	Rating Over Front	Rating Over Side or 360 degree	Rating Over Front	Rating Over Side or 360 degree	Rating Over Front	Rating Over Side or 360 degree	Rating Over Front	Rating Over Side or 360 degree	
30									* 9.36	* 9.36			* 8.38	* 8.38	9.15
25									* 11.44	* 11.44			* 8.23	* 8.23	9.78
20							* 13.62	* 13.62	* 12.03	11.75	* 9.72	8.61	* 8.34	8.34	10.28
15			* 26.60	* 26.60	* 18.99	* 18.99	* 15.16	* 15.16	* 12.88	11.2	* 11.41	8.34	* 8.71	7.53	10.65
10					* 21.70	20.62	* 16.70	14.44	* 13.76	10.63	* 11.85	8.02	* 9.34	7.09	10.93
5					* 23.51	19.3	* 17.89	13.62	* 14.47	10.12	12.15	7.73	* 10.31	6.94	11.10
0			* 28.31	* 28.31	* 24.09	18.59	* 18.47	13.07	* 14.81	9.76	11.94	7.53	11.27	7.09	10.87
-5	* 24.16	* 24.16	* 31.28	30.2	* 23.53	18.35	* 18.27	12.82	* 14.58	9.58			* 11.81	7.61	10.58
-10	* 32.85	* 32.85	* 28.23	* 28.23	* 21.85	18.45	* 17.14	12.83	* 13.46	9.63			* 11.93	8.65	10.18
-15	* 30.06	* 30.06	* 23.82	* 23.82	* 18.80	* 18.80	* 14.66	13.14					* 11.76	10.7	9.66
-20			* 17.10	* 17.10	* 13.53	* 13.53							* 10.71	* 10.71	8.99

Feet

Unit : 1,000lb

A(ft) B(ft)	10		15		20		25		30		35		Max. Reach		A(ft)
	Rating Over Front	Rating Over Side or 360 degree	Rating Over Front	Rating Over Side or 360 degree	Rating Over Front	Rating Over Side or 360 degree	Rating Over Front	Rating Over Side or 360 degree	Rating Over Front	Rating Over Side or 360 degree	Rating Over Front	Rating Over Side or 360 degree	Rating Over Front	Rating Over Side or 360 degree	
30													* 18.55	* 18.55	29.66
25									* 25.02	* 25.02			* 18.14	* 18.14	32.75
20							* 29.50	* 29.50	* 26.17	25.2			* 18.36	* 18.36	34.85
15			* 56.84	* 56.84	* 40.86	False	* 32.76	* 32.76	* 27.93	24.05	* 24.84	17.83	* 19.15	16.67	36.13
10					* 46.74	44.45	* 36.07	31.08	* 29.80	22.82	* 25.71	17.18	* 20.53	15.64	36.68
5					* 50.76	41.55	* 38.67	29.3	* 31.32	21.74	26.08	16.57	* 22.69	15.3	36.53
0			* 64.51	* 64.51	* 52.13	39.96	* 39.94	28.11	* 32.03	20.96	25.64	16.16	* 24.85	15.64	35.68
-5	* 54.04	* 54.04	* 67.72	64.66	* 50.96	39.4	* 39.50	27.55	* 31.45	20.59			* 26.03	16.79	34.07
-10	* 73.64	* 73.64	* 61.22	* 61.22	* 47.25	39.63	* 36.95	27.59	* 28.82	20.72			* 26.30	19.19	31.58
-15	* 64.94	* 64.94	* 51.36	* 51.36	* 40.40	* 40.40	* 31.25	28.32					* 25.89	23.89	27.98
-20			* 36.15	* 36.15	* 28.29	* 28.29							* 23.32	* 23.32	22.71

- RATINGS ARE BASED ON SAE J1097
- THE LOAD POINT IS A HOOK LOCATED ON THE BACK OF THE BUCKET.
- * RATED LOADS ARE BASED ON HYDRAULIC CAPACITY.
- RATED LOADS DO NOT EXCEED 87% OF HYD. CAPACITY OR 75% OF TIPPING CAPACITY.

 : Rating Over Front
 : Rating Over Side or 360 degree

Metric

Unit : 1,000kg



A(m) B(m)	3		4.5		6		7.5		9		10.5		Max. Reach		A(ft)		
	Rating Over Front	Rating Over Side or 360 degree	Rating Over Front	Rating Over Side or 360 degree	Rating Over Front	Rating Over Side or 360 degree	Rating Over Front	Rating Over Side or 360 degree	Rating Over Front	Rating Over Side or 360 degree	Rating Over Front	Rating Over Side or 360 degree	Rating Over Front	Rating Over Side or 360 degree			
9													* 10.66	* 10.66	8.60		
7.5									* 11.92	11.71			* 10.46	10.31	9.55		
6								* 14.17	* 14.17	* 12.40	11.35		* 10.62	8.78	10.19		
4.5							* 19.77	* 19.77	* 15.59	14.93	* 13.14	10.82	* 11.59	8	* 11.10	7.87	10.58
3							* 22.17	19.81	* 16.95	13.95	* 13.90	10.27	* 11.90	7.73	* 11.63	7.39	10.74
1.5							* 23.52	18.63	* 17.91	13.18	* 14.45	9.81	11.91	7.49	11.55	7.25	10.69
0							* 23.62	18.09	* 18.21	12.72	* 14.59	9.5			11.91	7.45	10.42
-1.5					* 29.07	* 29.07	* 22.62	18.01	* 17.71	12.56	* 14.08	9.4			* 12.10	8.07	9.92
-3	* 30.81	* 30.81	* 25.80	* 25.80	* 20.52	18.26	* 16.19	12.69	* 12.45	9.57					* 12.07	9.36	9.14
-4.5	* 24.55	* 24.55	* 20.93	* 20.93	* 16.92	* 16.92	* 13.03	* 13.03							* 11.58	* 11.58	8.00
-6							* 10.46	* 10.46							* 9.59	* 9.59	6.32

Feet

Unit : 1,000lb

A(ft) B(ft)	10		15		20		25		30		35		Max. Reach		A(ft)		
	Rating Over Front	Rating Over Side or 360 degree	Rating Over Front	Rating Over Side or 360 degree	Rating Over Front	Rating Over Side or 360 degree	Rating Over Front	Rating Over Side or 360 degree	Rating Over Front	Rating Over Side or 360 degree	Rating Over Front	Rating Over Side or 360 degree	Rating Over Front	Rating Over Side or 360 degree			
30													* 23.59	* 23.59	27.85		
25									* 26.09	25.01			* 23.06	* 23.06	31.12		
20									* 30.68	* 30.68	* 26.97	24.32			* 23.37	19.52	33.33
15							* 42.54	* 42.54	* 33.68	32.13	* 28.49	23.23			* 24.41	17.43	34.67
10							* 47.78	42.72	* 36.62	30.03	* 30.09	22.06	* 25.80	16.54	* 25.63	16.31	35.24
5							* 50.81	40.11	* 38.72	28.37	* 31.26	21.06	25.56	16.05	25.45	15.97	35.09
0					* 60.08	* 60.08	* 51.15	38.89	* 39.39	27.35	* 31.52	20.41			26.25	16.42	34.20
-5					* 63.27	* 63.27	* 49.02	38.68	* 38.28	27	* 30.32	20.21			* 26.68	17.83	32.51
-10	* 67.35	* 67.35	* 56.01	* 56.01	* 44.38	39.22	* 34.85	27.3							* 26.60	20.76	29.89
-15	* 53.05	* 53.05	* 45.10	* 45.10	* 36.27	* 36.27	* 27.51	* 27.51							* 25.43	* 25.43	26.06
-20							* 21.17	* 21.17							* 20.57	* 20.57	20.28

- RATINGS ARE BASED ON SAE J1097
- THE LOAD POINT IS A HOOK LOCATED ON THE BACK OF THE BUCKET.
- * RATED LOADS ARE BASED ON HYDRAULIC CAPACITY.
- RATED LOADS DO NOT EXCEED 87% OF HYD. CAPACITY OR 75% OF TIPPING CAPACITY.

 : Rating Over Front
 : Rating Over Side or 360 degree

Lifting Capacity

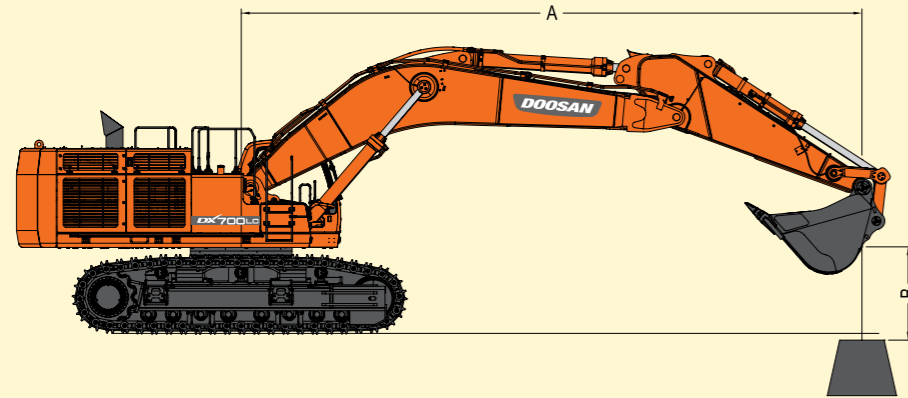

Option 2

Boom : 7,700mm(25'3") Arm : 4,200mm(13'9") Bucket : SAE 3.0m³ Shoe : 650mm(2'2") GP Bucket 11,300kg C/W

Metric Unit : 1,000kg

A(m) B(m)	1.5		3		4-5		6		7-5		9		10.5		Max. Reach		A(ft)
	☺	☹	☺	☹	☺	☹	☺	☹	☺	☹	☺	☹	☺	☹	☺	☹	
9																	9.94
7.5																	10.78
6																	11.35
4.5																	11.70
3																	11.84
1.5																	11.80
0																	11.56
-1.5																	11.10
-3																	10.41
-4.5																	9.43
-6																	8.07

Feet Unit : 1,000lb

A(ft) B(ft)	5		10		15		20		25		30		35		Max. Reach		A(ft)
	☺	☹	☺	☹	☺	☹	☺	☹	☺	☹	☺	☹	☺	☹	☺	☹	
30																	32.32
25																	35.17
20																	37.13
15																	38.33
10																	38.85
5																	38.71
0																	37.91
-5																	36.40
-10																	34.08
-15																	30.77
-20																	26.10

1. RATINGS ARE BASED ON SAE J1097
 2. THE LOAD POINT IS A HOOK LOCATED ON THE BACK OF THE BUCKET.
 3. * RATED LOADS ARE BASED ON HYDRAULIC CAPACITY.
 4. RATED LOADS DO NOT EXCEED 87% OF HYD. CAPACITY OR 75% OF TIPPING CAPACITY.

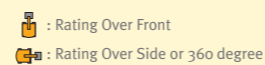

Option 3

Boom : 6,650mm(21'10") Arm : 2,900mm(9'6") Bucket : SAE 3.9m³ Shoe : 650mm(2'2") GP Bucket 11300kg C/W

Metric Unit : 1,000kg

A(m) B(m)	3		4-5		6		7-5		9		Max. Reach		A(ft)
	☺	☹	☺	☹	☺	☹	☺	☹	☺	☹	☺	☹	
7.5													8.26
6													8.99
4.5													9.43
3													9.61
1.5													9.56
0													9.26
-1.5													8.68
-3													7.78
-4.5													6.40

Feet Unit : 1,000lb

A(ft) B(ft)	10		15		20		25		30		Max. Reach		A(ft)
	☺	☹	☺	☹	☺	☹	☺	☹	☺	☹	☺	☹	
25													26.86
20													29.38
15													30.89
10													31.54
5													31.37
0													30.37
-5													28.45
-10													25.41
-15													20.73

Option 4

Boom : 6,650mm(21'10") Arm : 2,600mm(8'6") Bucket : SAE 4.5m³ Shoe : 650mm(2'2") GP Bucket 11,300kg C/W

Metric Unit : 1,000kg

A(m) B(m)	3		4-5		6		7-5		9		Max. Reach		A(ft)
	☺	☹	☺	☹	☺	☹	☺	☹	☺	☹	☺	☹	
7.5													7.98
6													8.73
4.5													9.18
3													9.37
1.5													9.31
0													9.00
-1.5													8.41
-3													7.48
-4.5													6.03

Feet Unit : 1,000lb

A(ft) B(ft)	10		15		20		25		30		Max. Reach		A(ft)
	☺	☹	☺	☹	☺	☹	☺	☹	☺	☹	☺	☹	
25													25.91
20													28.53
15													30.08
10													30.74
5													30.57
0													29.54
-5													27.57
-10													24.41
-15													19.49

1. RATINGS ARE BASED ON SAE J1097
 2. THE LOAD POINT IS A HOOK LOCATED ON THE BACK OF THE BUCKET.
 3. * RATED LOADS ARE BASED ON HYDRAULIC CAPACITY.
 4. RATED LOADS DO NOT EXCEED 87% OF HYD. CAPACITY OR 75% OF TIPPING CAPACITY.

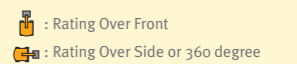



Doosan worldwide factories

- Heavy Equipment Factory
- Compact Equipment Factory
- Attachment Factory



Doosan Infracore Korea Office (HQ)
 27/F, Doosan Tower 18-12, Euljiro-6Ga, Jung-Gu
 Seoul 100-730 Korea
 Tel : 82 2 3398 8114

www.doosaninfracore.com/ce/